

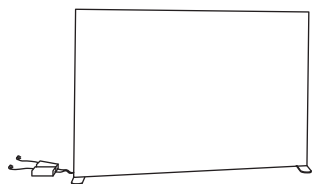









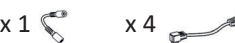

ELENCO DEI COMPONENTI

n.2 PARETI ILLUMIWALL cm 285x250H - CIASCUNA PARETE COMPRENDE



<p>LED ORIZZONTALI SEG 85 LED x 2 SEG 100 LED x 4</p> 	<p>SEGMENTI VERTICALI</p> <p>SEG 50 x 1 } NON CABLATI SEG 100 x 2 }</p> <p>SEG 50 x 1 } CABLATI M/F SEG 100 x 1 }</p> <p>SEG 100 x 1 } CABLATI M/M</p> 			<p>CONNETTORI x 8</p>  <p>ANGOLARI SUPERIORI x 2</p> 	<p>TRASFORMATORI x 2</p>  <p>CAVI DI RACCORDO x 1 x 4</p> 
<p>SUPPORTI ORIZZONTALI 85 x 2 100 x 4</p> 	<p>SUPPORTI VERTICALI 50 x 2 100 x 4</p> 	<p>CROCI DI SUPPORTO x 4</p> 	<p>BASI ANGOLARI x 2</p> 	<p>BASI INTERMEDIE x 2</p> 	



n.2 CLIP 90° per l'unione delle 2 pareti

ASSEMBLAGGIO DELLE 2 PARETI

Si invita ad eseguire l'assemblaggio seguendo le etichette ed i simboli presenti sui vari componenti.
Per maggiori dettagli su come innestare i componenti fra loro, scansionare il QRcode e guardare i video tutorial.

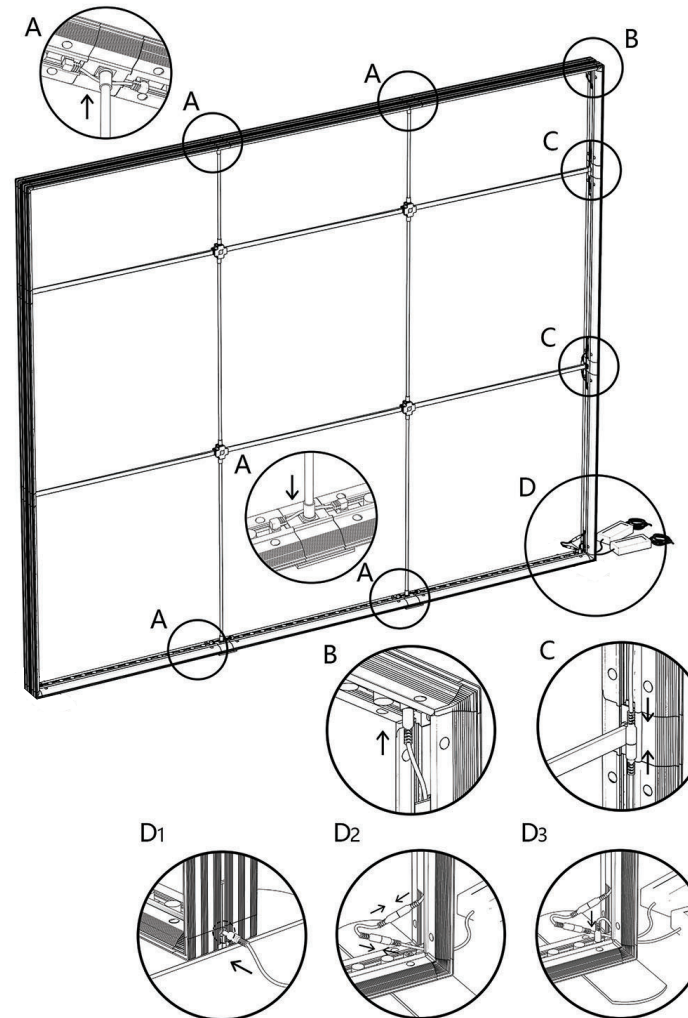
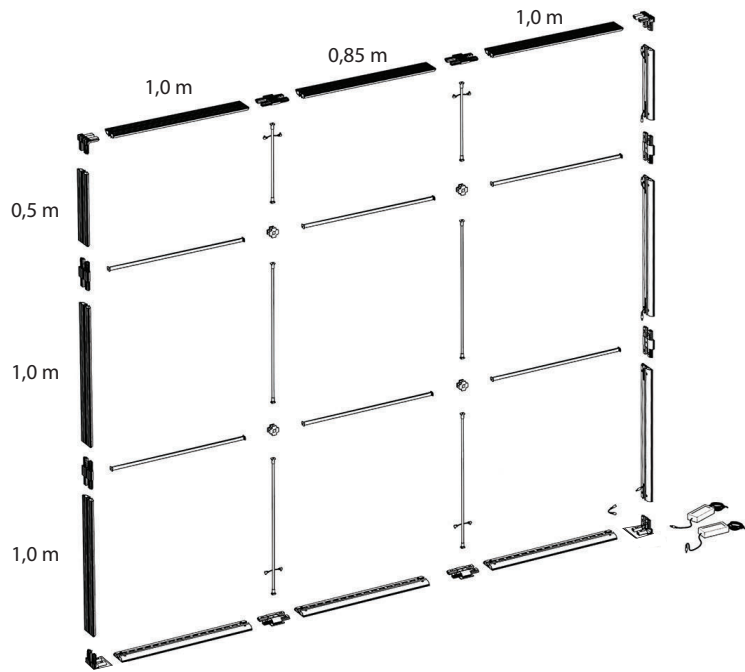

inquadra qui



STAND ANGOLARE 300X300X250H

UNIONE DELLE 2 PARETI TRA LORO



Accostare tra loro le 2 pareti come da figura (possibilmente i trasformatori vanno verso l'angolo di unione).

Infilare le 2 clip da 90° nelle guide lungo il profilo delle pareti accostate tra di loro, ruotare e bloccare le leve di ancoraggio.

Fissare le grafiche alle 2 pareti inserendo la guida in silicone all'interno degli appositi binari. Per avere le migliori performance a livello di illuminazione, il lato posteriore deve essere tassativamente chiuso da grafiche o da apposito telo oscurante.

