

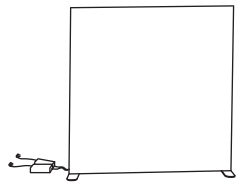













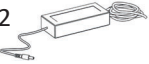







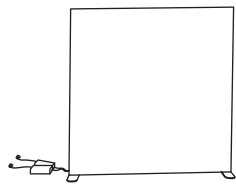





n.1 PARETE ILLUMIWALL cm 170x250H

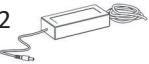

LED ORIZZONTALI SEG 85 LED x 4 	SEGMENTI VERTICALI SEG 50 x 1 } NON CABLATI SEG 100 x 2 }  			SEG 50 x 1 } CABLATI M/F SEG 100 x 1 } 	SEG 100 x 1 } CABLATI M/M 	CONNETTORI x 6 	TRASFORMATORI x 2 
ANGOLARI SUPERIORI x 2 		CAVI DI RACCORDO x 1 		x 2 			
SUPPORTI ORIZZONTALI 85 x 4 	SUPPORTI VERTICALI 50 x 1 100 x 2 	CROCI DI SUPPORTO x 2 	BASI ANGOLARI x 2 	BASI INTERMEDIE x 1 			

n.2 PARETI ILLUMIWALL cm 185x250H - CIASCUNA PARETE COMPRENDE

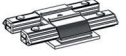

LED ORIZZONTALI SEG 85 LED x 2 SEG 100 LED x 2 	SEGMENTI VERTICALI SEG 50 x 1 } NON CABLATI SEG 100 x 2 }  			SEG 50 x 1 } CABLATI M/F SEG 100 x 1 } 	SEG 100 x 1 } CABLATI M/M 	CONNETTORI x 6 	TRASFORMATORI x 2 
ANGOLARI SUPERIORI x 2 		CAVI DI RACCORDO x 1 		x 2 			
SUPPORTI ORIZZONTALI 85 x 2 100 x 2 	SUPPORTI VERTICALI 50 x 1 100 x 2 	CROCI DI SUPPORTO x 2 	BASI ANGOLARI x 2 	BASI INTERMEDIE x 1 			



n.4 CLIP 90° per l'unione delle 2 pareti

CUBOSTAND 200X200X250H

ASSEMBLAGGIO PARETE DI FONDO

Si invita ad eseguire l'assemblaggio seguendo le etichette ed i simboli presenti sui vari componenti.
Per maggiori dettagli su come innestare i componenti fra loro, scansionare il QRcode e guardare i video tutorial.

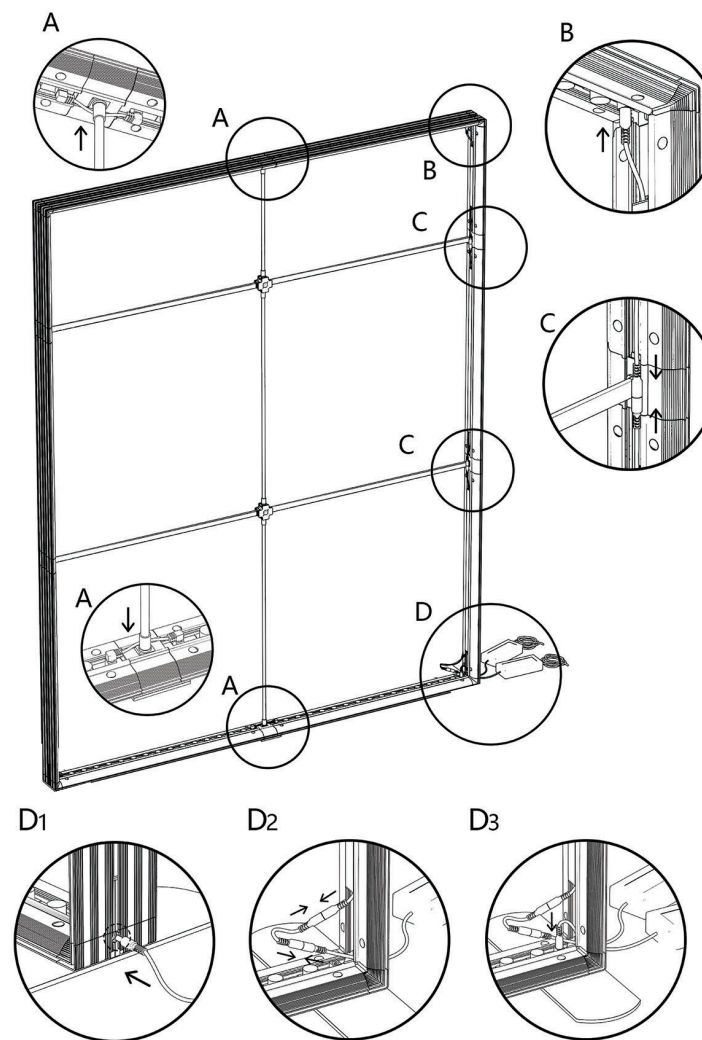
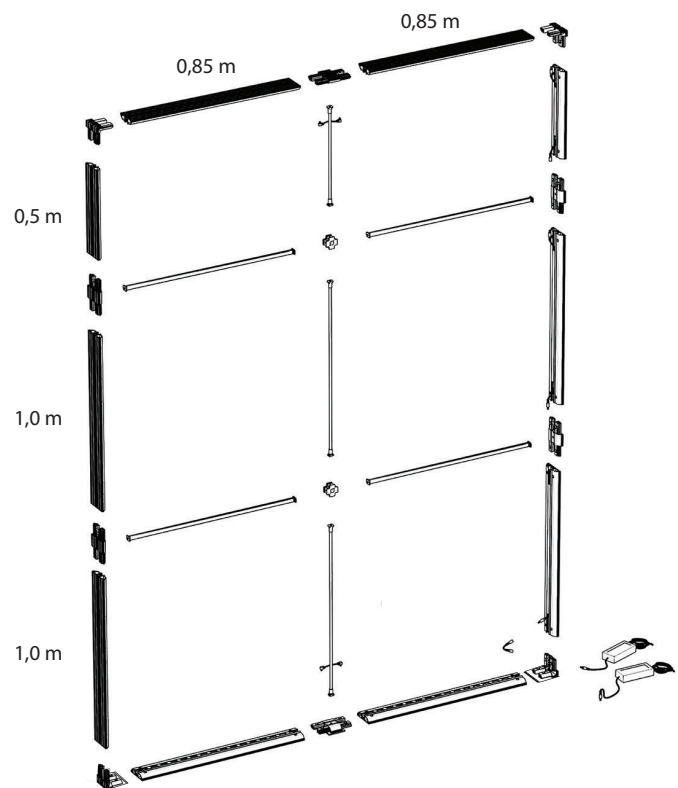

CUBOSTAND 200X200X250H

ASSEMBLAGGIO PARETI LATERALI

Si invita ad eseguire l'assemblaggio seguendo le etichette ed i simboli presenti sui vari componenti.
Per maggiori dettagli su come innestare i componenti fra loro, scansionare il QRcode e guardare i video tutorial.

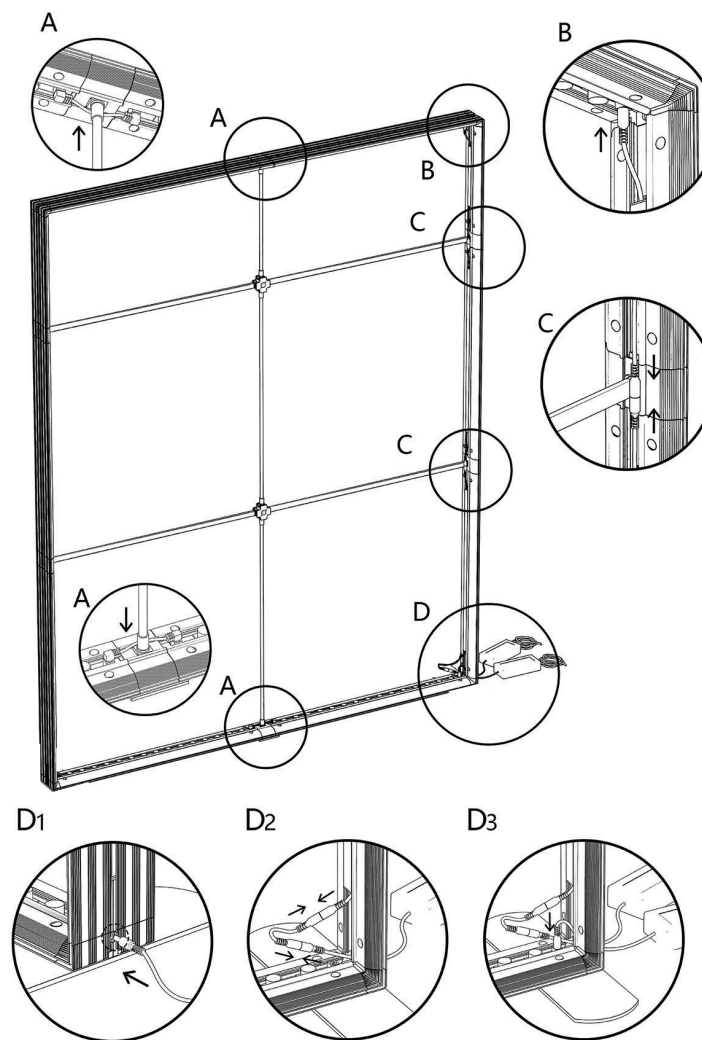
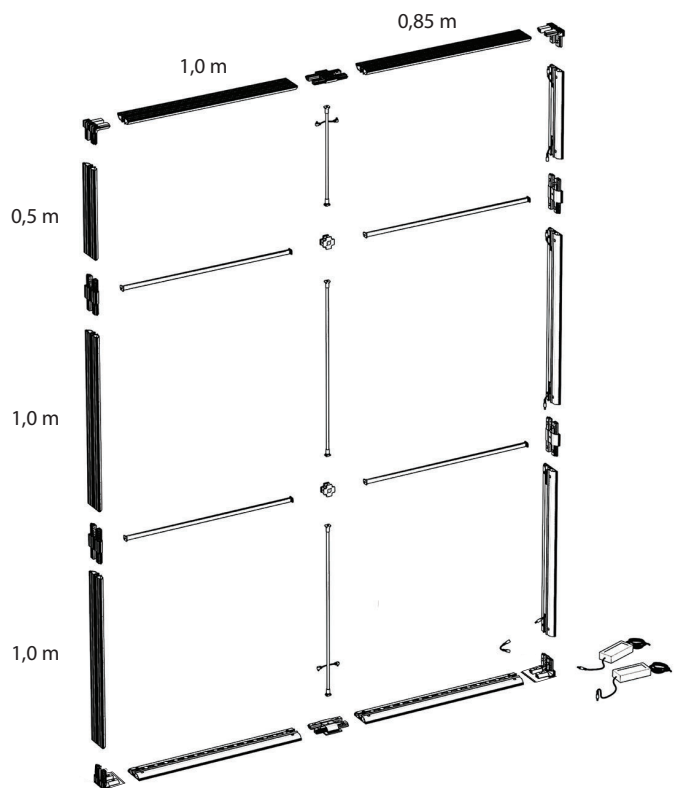

inquadra qui

CUBOSTAND 200X200X250H

UNIONE DELLE 3 PARETI TRA LORO

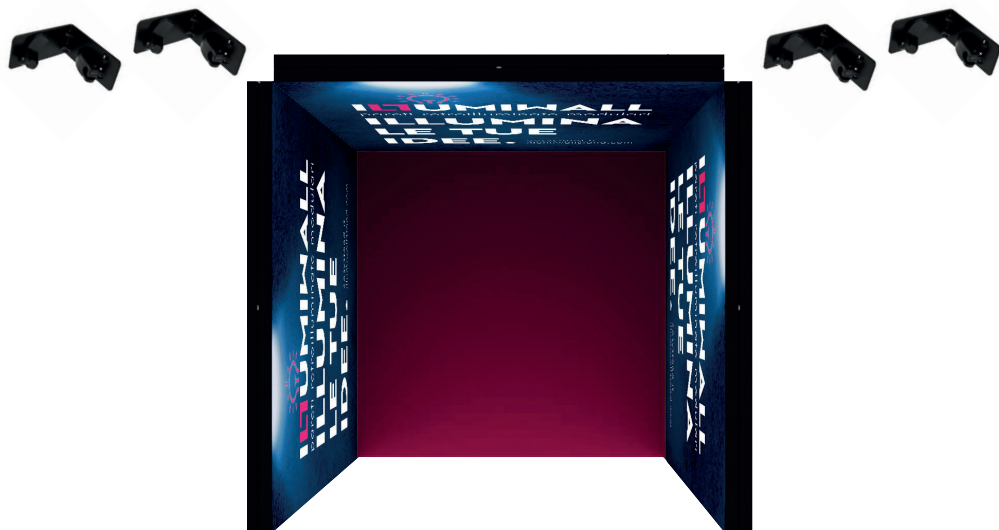

Accostare tra loro le 3 pareti come da figura (possibilmente i trasformatori vanno verso l'angolo di unione).

Infilare le 4 clip da 90° nelle guide lungo il profilo delle pareti accostate tra di loro, ruotare e bloccare le leve di ancoraggio.

Fissare le grafiche alle 3 pareti inserendo la guida in silicone all'interno degli appositi binari. Per avere le migliori performance a livello di illuminazione, il lato posteriore deve essere tassativamente chiuso da grafiche o da apposito telo oscurante.

