







## COMPOSIZIONE della STRUTTURA

20	TRALICCIO 140cm 	12	CLIP SUPERIORI 
8	CUBO 	12	CLIP INFERIORI con ELASTICO 
10	CONNETTORE a X 	12mt	BARRE d'ALLUMINIO 
4	BASE 16x16cm 	2	TELI in PVC con GRAFICHE 



LEGGI LE  
ISTRUZIONI

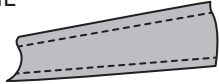
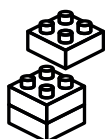

ASSEMBLA  
IL TUO EASYSTAND



FOTOGRAFA O FILMA  
IL RISULTATO



CERCA LL. LITTLE AND LARGE SOLUTIONS e EASYSTAND.IT  
SUI TUOI SOCIAL PREFERITI E CONDIVIDILO CON NOI!

SEGUONO ISTRUZIONI DI MONTAGGIO



## ISTRUZIONI di ASSEMBLAGGIO dei COMPONENTI

A

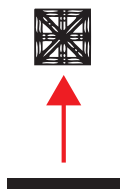

### **FISSAGGIO del CUBO alla BASE:**

Avvicinare il cubo alla base, facendo calzare i piolini di cui quest'ultimo è dotato con i fori situati sulla base stessa. In seguito avvitare a mano la vite di cui la base è dotata, senza forzare troppo (è necessario arrivare a fine corsa, senza utilizzare avvitatori o attrezzi).

B



### **FISSAGGIO del CUBO al TRALICCIO:**

Avvicinare e congiungere il traliccio al cubo, facendo calzare i piolini di cui quest'ultimo è dotato con i fori ai 4 angoli della faccia del traliccio. In seguito avvitare a mano la vite di cui il traliccio è dotato, senza forzare troppo (è necessario arrivare a fine corsa, senza utilizzare avvitatori o attrezzi).

C



### **FISSAGGIO dei TRALICCI con CONNETTORE:**

Avvicinare e congiungere i tralicci interponendo tra loro il connettore a X. In seguito avvitare a mano le viti di cui i tralicci sono dotati, senza forzare troppo (si consiglia di arrivare a fine corsa, senza utilizzare attrezzi o avvitatori).

D



### **FISSAGGIO delle STAMPE:**

(teli in PVC mono o bifacciali)

Inserire le barre di alluminio all'interno delle asole dei teli (a filo stampa), infilare le CLIP ed assicurare le stesse ai tralicci. (clip SUPERIORI nella parte alta del telo e clip INFERIORI con ELASTICO in basso).

Una clip ogni 100cm circa.



## ISTRUZIONI di MONTAGGIO

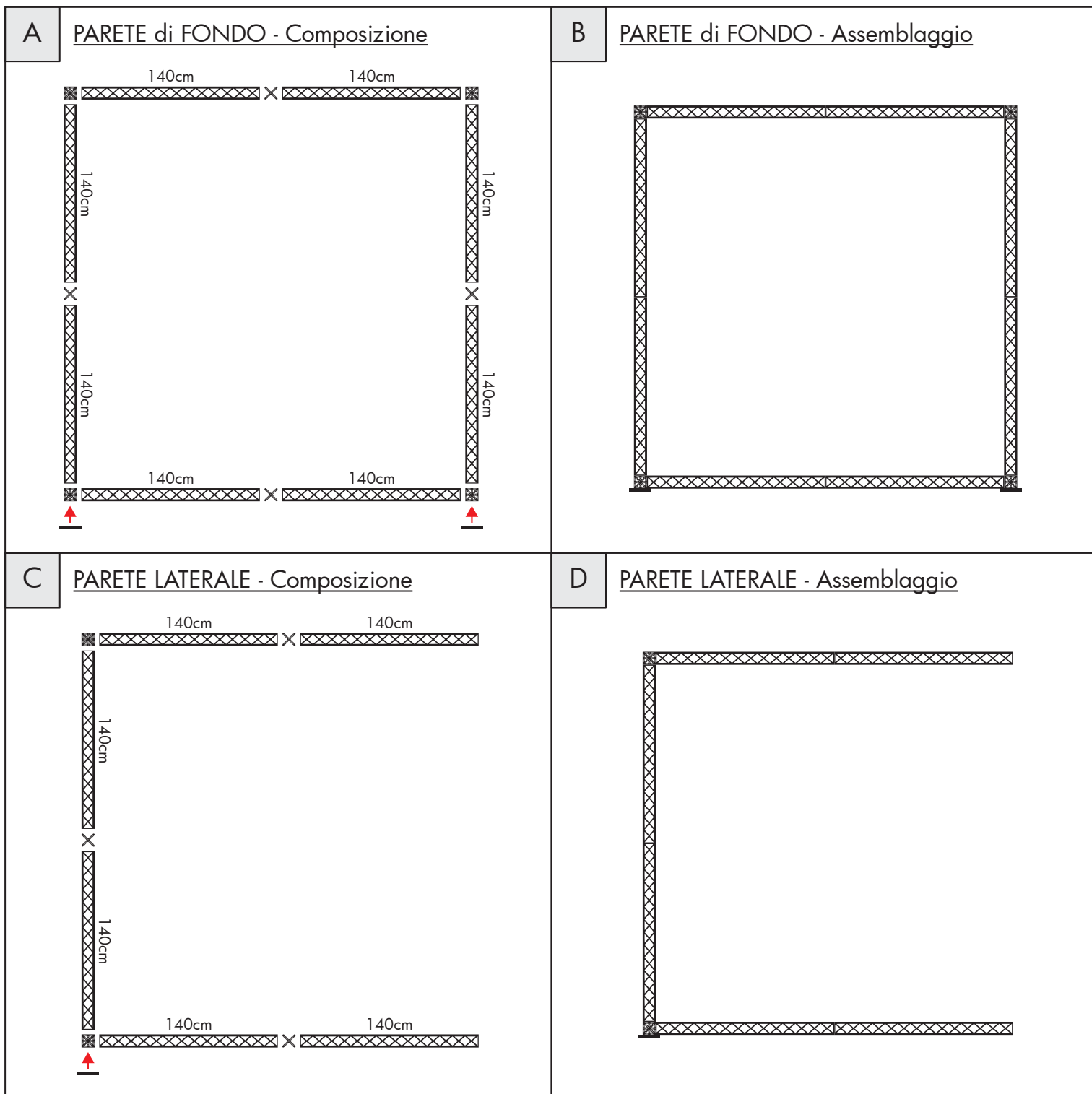

## ISTRUZIONI di MONTAGGIO

### E UNIONE dei COMPONENTI

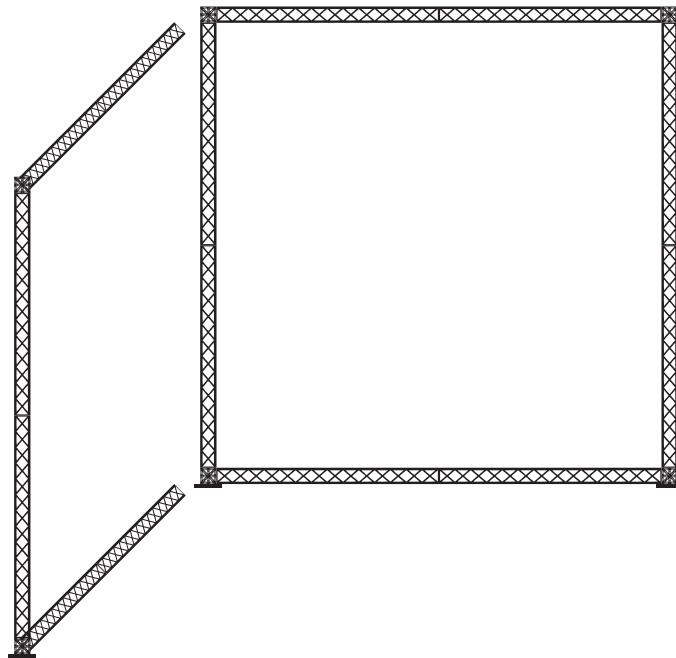

### F RING ANTERIORE - Composizione

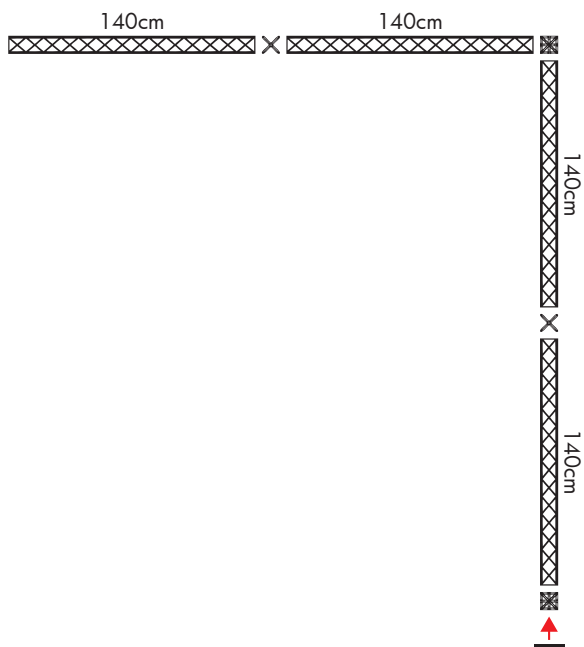

### G RING ANTERIORE - Assemblaggio

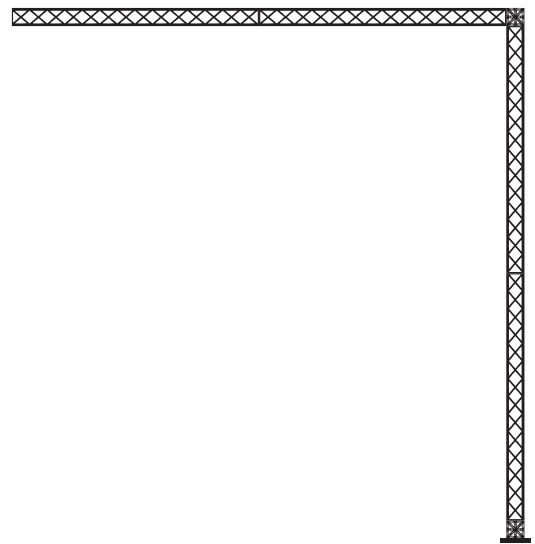

## ISTRUZIONI di MONTAGGIO

### H RING LATERALE - Composizione



### I RING LATERALE - Assemblaggio



### L UNIONE dei COMPONENTI

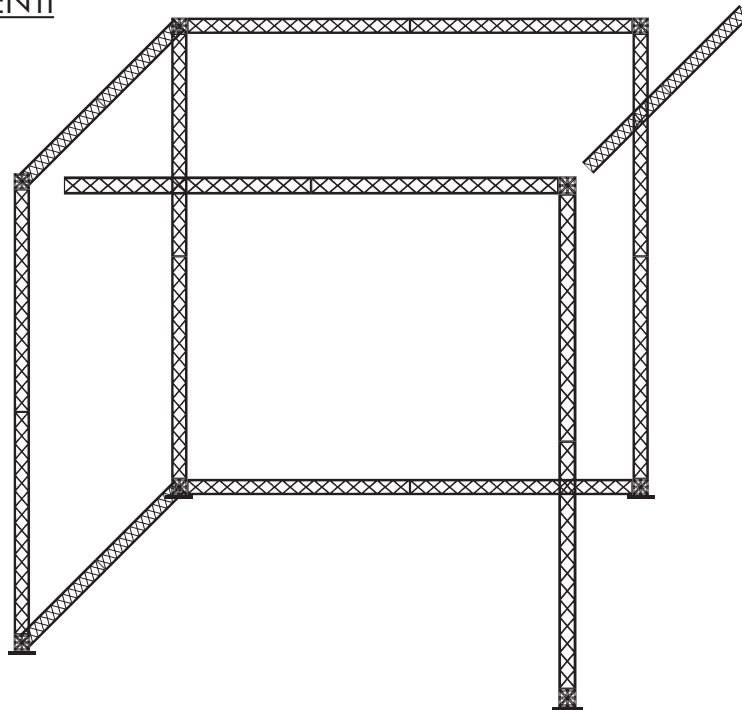

## ISTRUZIONI di MONTAGGIO

### M FISSAGGIO GRAFICHE e RISULTATO FINALE

